

Product Information



FTP100x50-Ø20 HL60

EAN 4031582329391

Wheel centre made of cast iron, Tread: Polyurethane, casted, precision ball bearing

Technical Data	
Wheel diameter	100 mm
Width of Tread	50 mm
Axle Hole-Ø	20 mm
Hub length	60 mm
Temperature	- 20 / + 60 °C
Standard	EN 12533
Weight	1.676 kg
Load capacity	450 kg
Load capacity (static)	900 kg
Hardness of tread	A 92 Shore



Roll performance	+	+	+	+	+
Movement noise	+	+	+	+	+
Attrition	+	+	+	+	+
Corrosion resistance	+	+	+	+	+

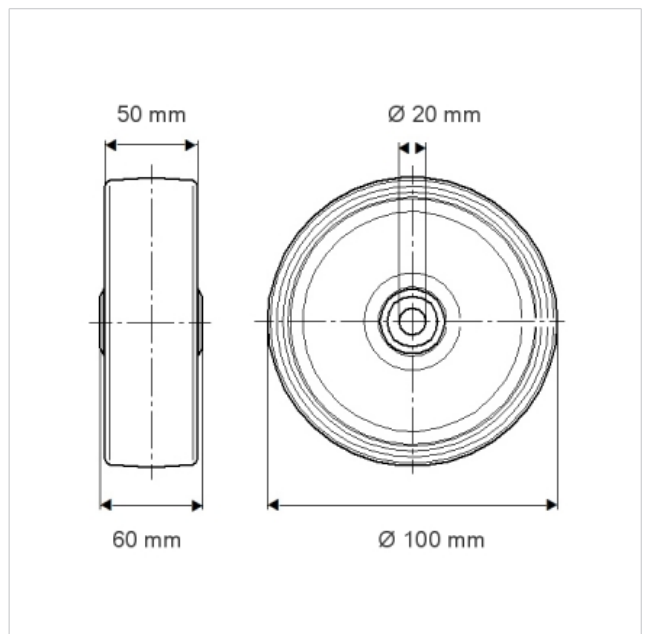



FTP100x50-Ø20 HL60

EAN 4031582329391

