

Product Information



9250STP250P65

EAN 4031582314038

Swivel castor, housing and plate steel-welded, zinc plated, blue passivated, sealed swivel bearing with dual purpose bearing and tapered roller bearing, threaded king pin and locking nut secured, grease nipple, wheel axle with nut. Wheel centre made of pressed steel, lacquered, heavy duty, Tread: Polyurethane, casted, precision ball bearing, plate fitting



Technical Data	
Wheel diameter	250 mm
Width of Tread	100 mm
Size of Plate	200 x 160 mm
Plate hole centres	160 x 120 mm
Plate hole	15 mm
Offset	75 mm
Swivel Interference	400 mm
Overall height	325 mm
Temperature	- 20 / + 60 °C
Standard	EN 12533
Weight	33.626 kg
Load capacity	2200 kg
Load capacity (static)	4400 kg
Swivel Radius	200 mm
Hardness of tread	A 92 Shore

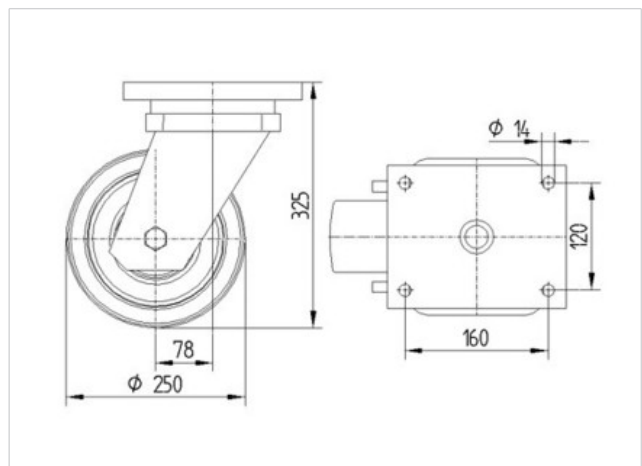

Roll performance	+	+	+	+	+
Movement noise	+	+	+	+	+
Attrition	+	+	+	+	+
Corrosion resistance	+	+	+	+	+



9250STP250P65

EAN 4031582314038

